

# EN1176

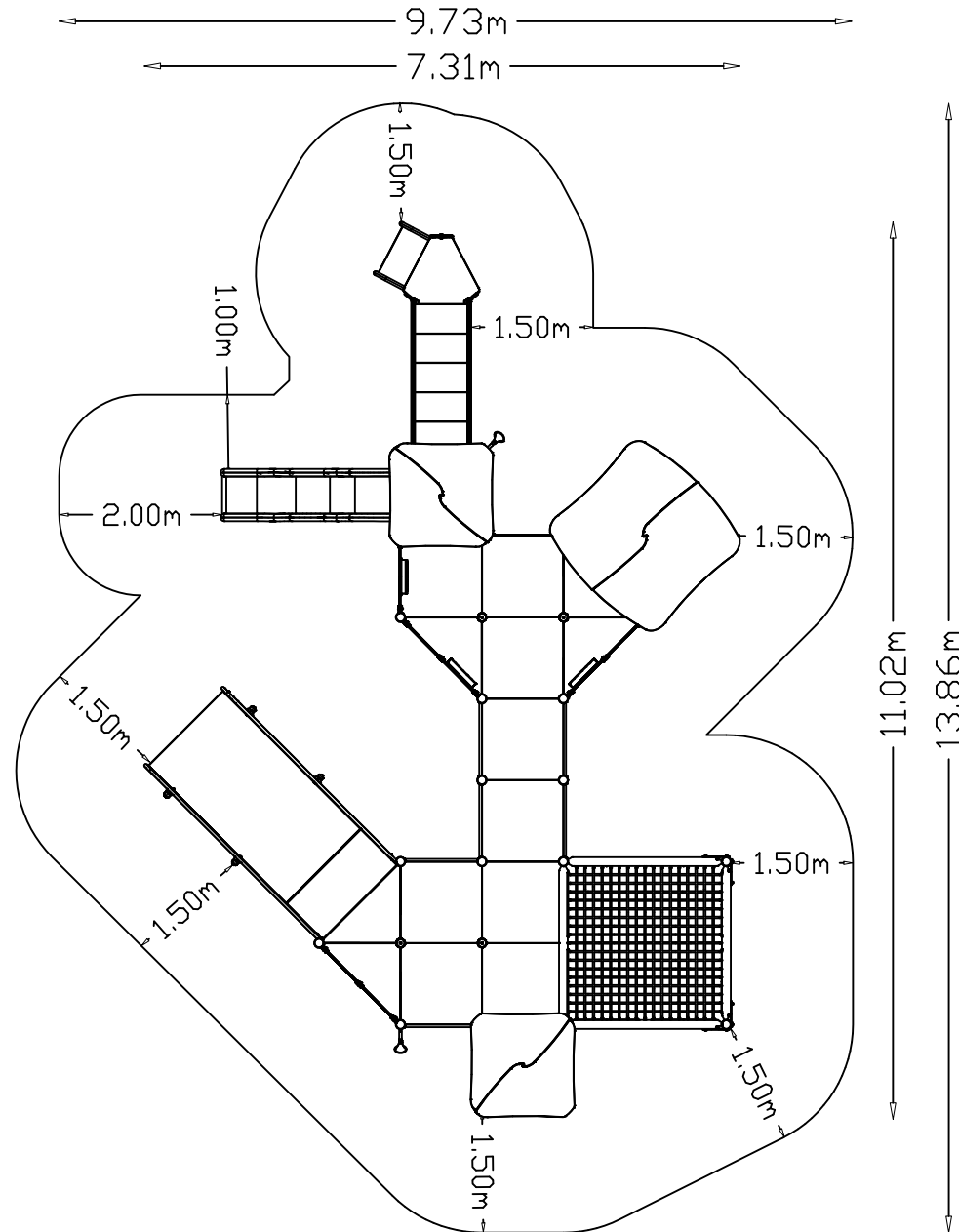

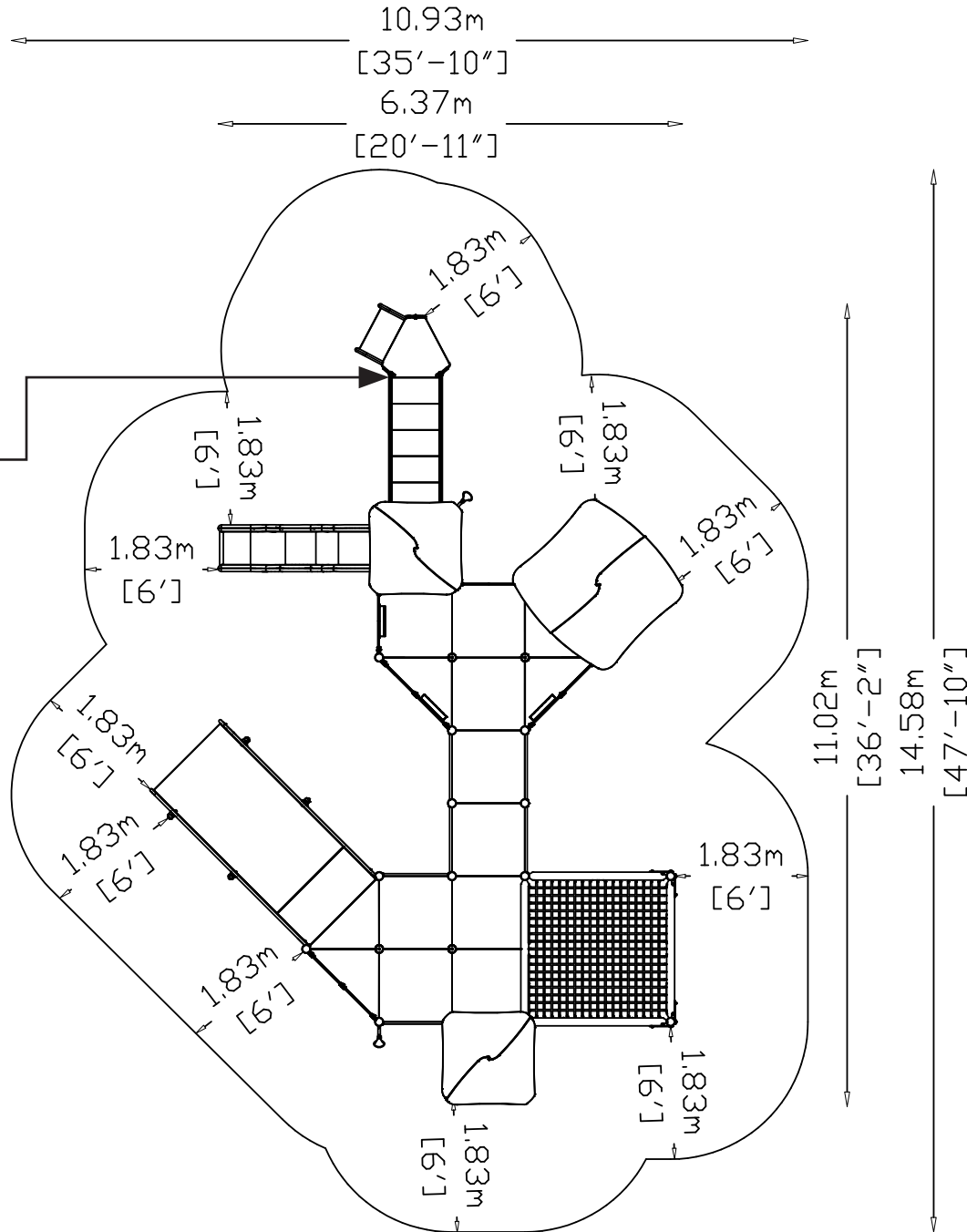

# ASTM F1487

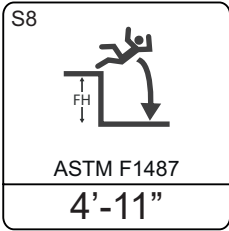

 <b>INSTALL 101</b>	<b>WARNING</b> Playground equipment used for first use should be inspected regularly or periodically after the initial use to ensure safety. Check for any damage or wear before allowing children to play.	<b>play smart! rules</b> Do not play on broken or damaged equipment. Report it. Do not play without adequate safety supervision. No tobacco, alcohol or drugs should be used while playing. Do not play on or near playground equipment and its structure if it is damaged. Wash your hands. Do not run, climb, swing, slide, or use equipment in a way not intended by the manufacturer. Do not play on swings or any equipment if the seats or on top of seats are broken or damaged. Do not sit on the ground or on the ground while playing. Do not have meals or snacks while playing. Do not have drinks while playing. Do not have toys while playing. Do not have pets while playing. Do not have pets while playing. Do not have pets while playing.
	<b>WARNING</b> Children are required to use the proper technique when using any playground equipment. Before allowing children to play, check for any damage or wear before allowing children to play. Children should wear appropriate shoes at all times.	Do not play on or near playground equipment and its structure if it is damaged. Wash your hands. Do not run, climb, swing, slide, or use equipment in a way not intended by the manufacturer. Do not play on swings or any equipment if the seats or on top of seats are broken or damaged. Do not sit on the ground or on the ground while playing. Do not have meals or snacks while playing. Do not have drinks while playing. Do not have toys while playing. Do not have pets while playing. Do not have pets while playing.
	<b>WARNING</b> All playground equipment and rubber surfacing should be inspected regularly or periodically after the initial use to ensure safety. Check for any damage or wear before allowing children to play. Children should wear appropriate shoes at all times.	Adults - do not slide with a child on your lap. Do not ride your child's back. Before letting go of overhead bars, hand grips and handrails, a child should stand with both feet on the ground and hold onto the handrails. The structure while playing and be seated.





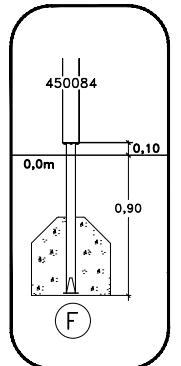
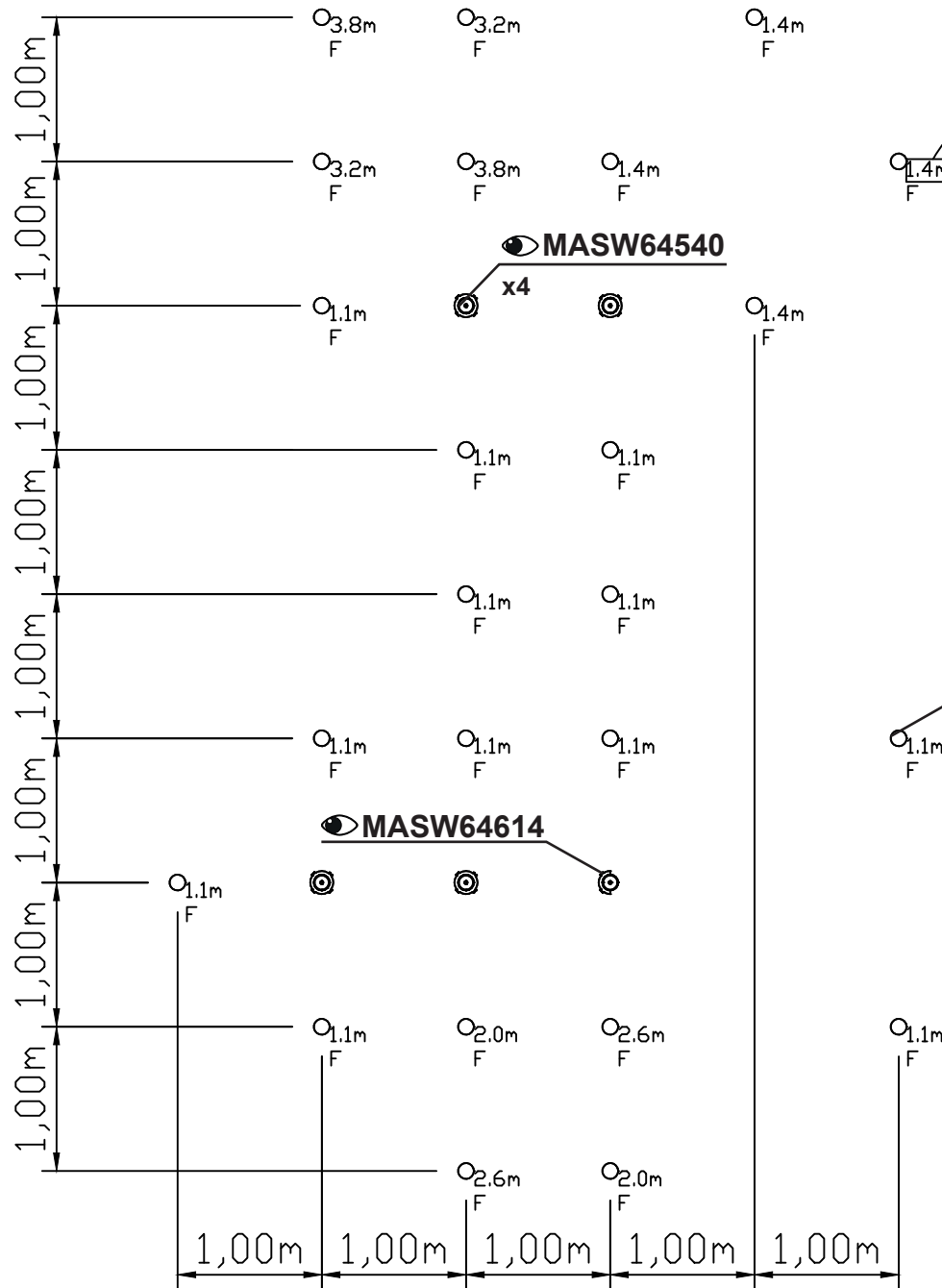
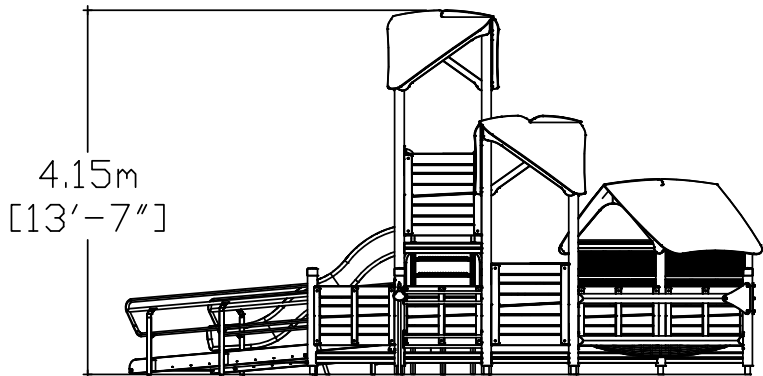
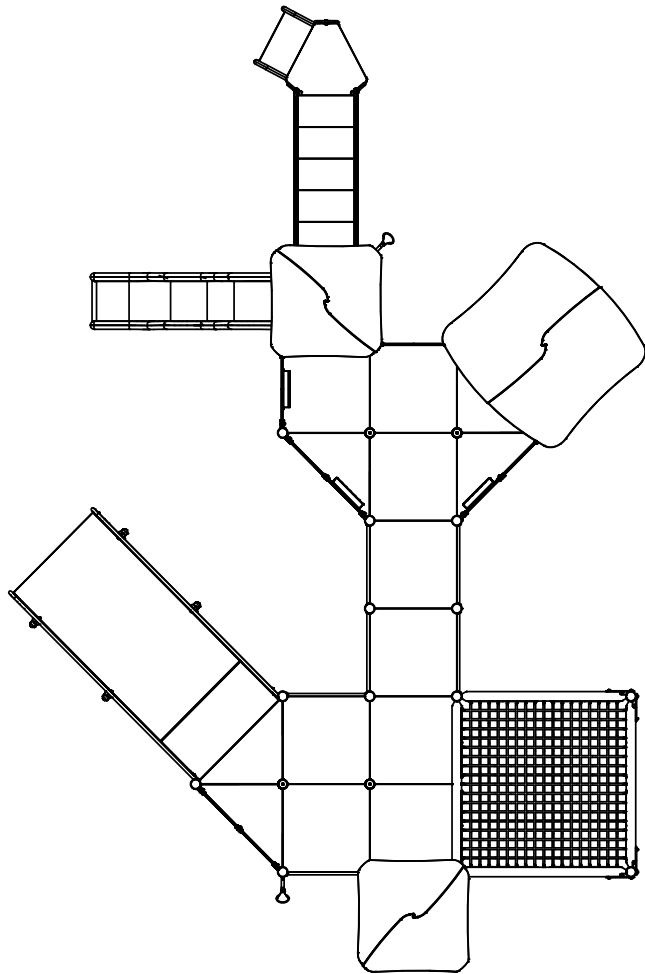

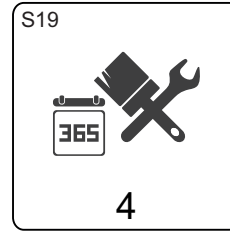
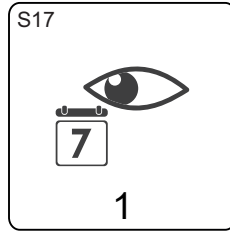
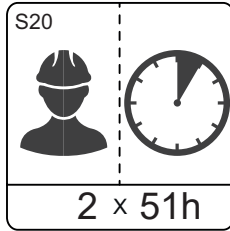
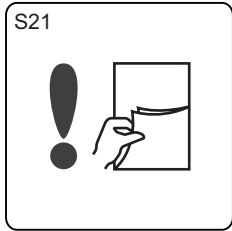

**Install 101**  
**260329**  
**420930**  
**420942**  
**420960**  
**420970**  
**441000**  
**450080**  
**696405**  
**42060530**  
**45091210**  
**45275323**  
**45475323**  
**MA422U75510**  
**MA424U75510**  
**MA45060310**  
**MA45060522**  
**MA45060740**  
**MA45070810**  
**MA62483**  
**MA62693**  
**MASW103874**  
**MASW35156**  
**MASW39775**

**MASW46128**  
**MASW60649**  
**MASW60650**  
**MASW63820**  
**MASW63840**  
**MASW85869**  
**MASW64540**  
**MASW64614**  
**ST4203**

450080

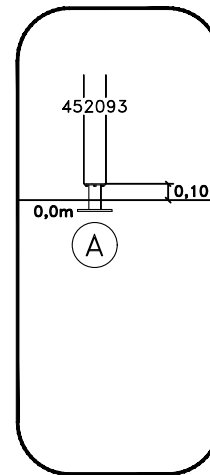

**Above Ground**  
**OM**

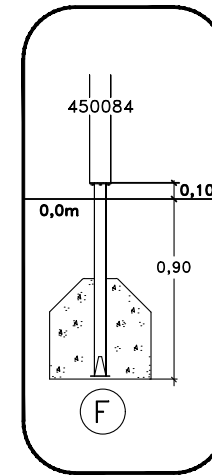

**Cast Loose Fill**  
**BM**  
8102045

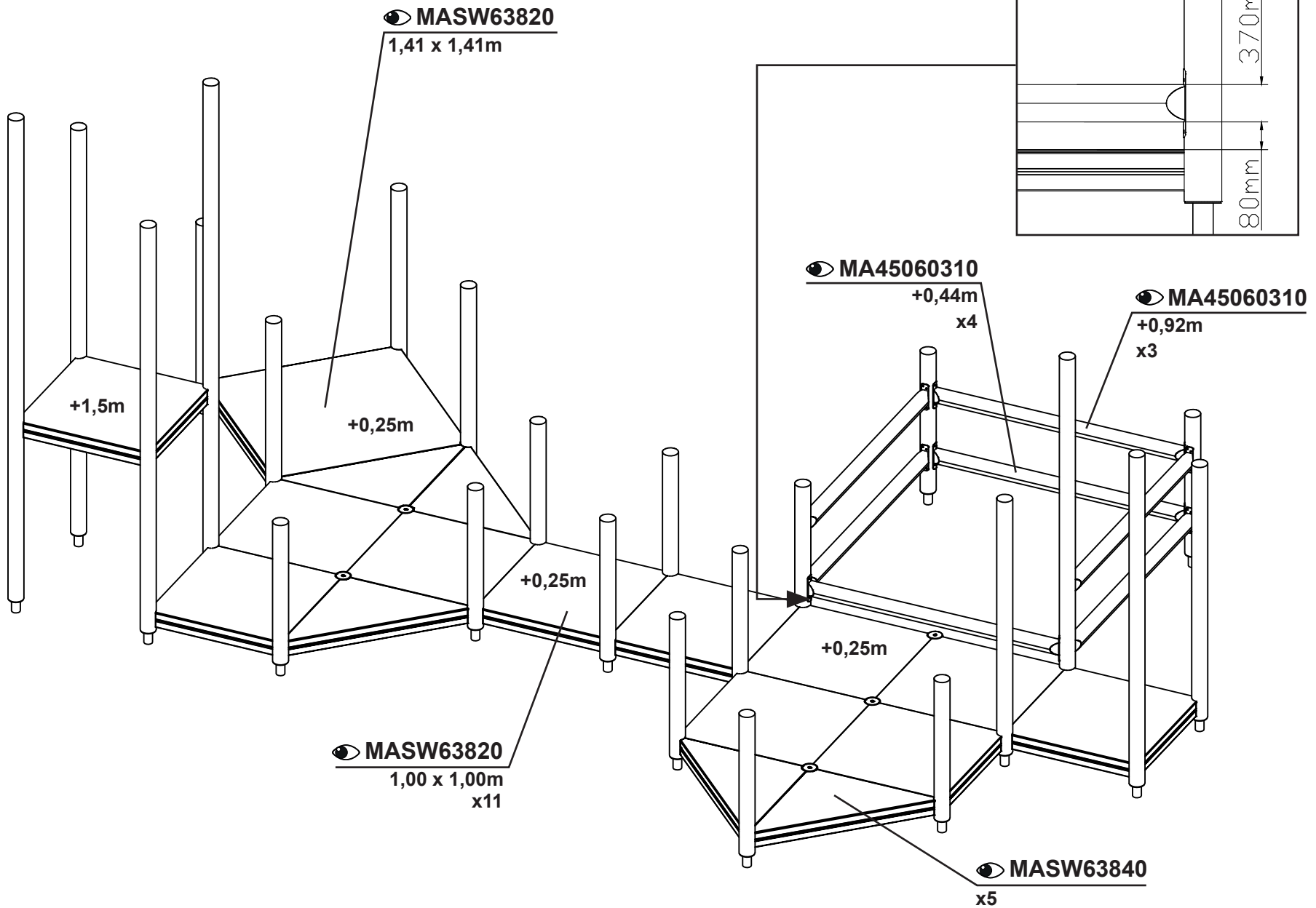
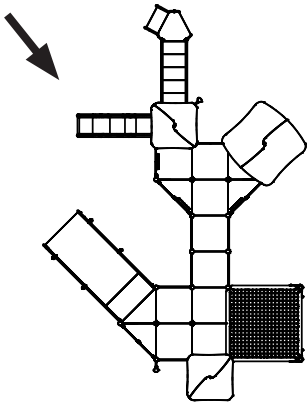

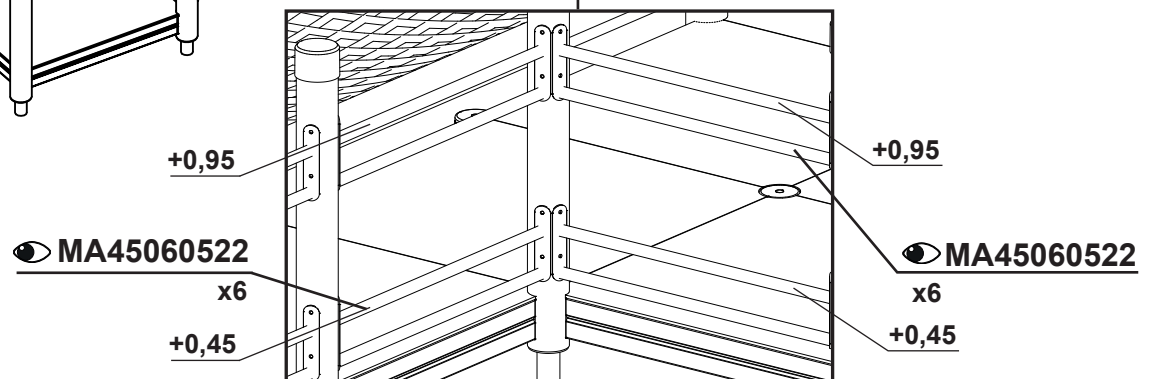
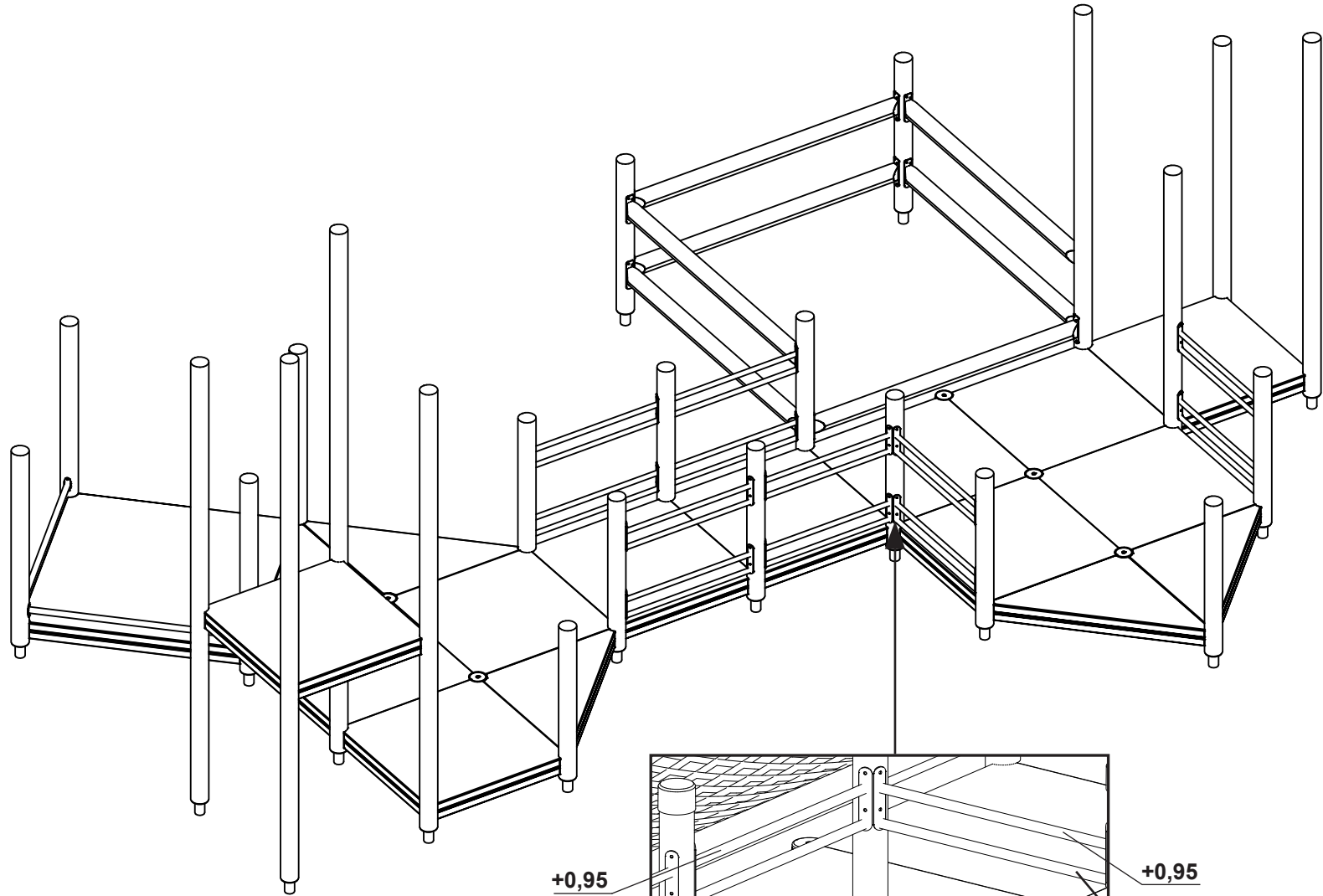
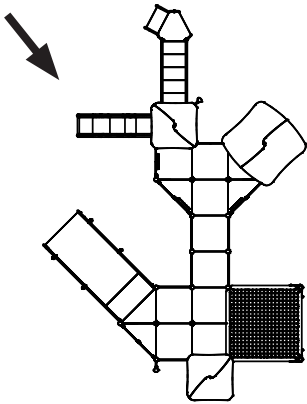

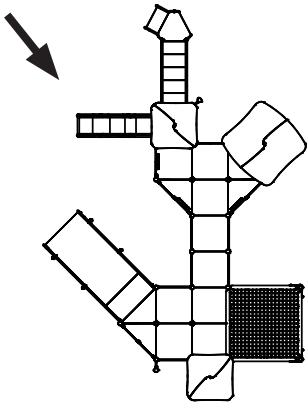

● MASW60650

● MASW60649

● MASW60649

● ST4203  
8066754

● 42060530  
+0,36

● ST4203  
8066760

● ST4203  
8066760

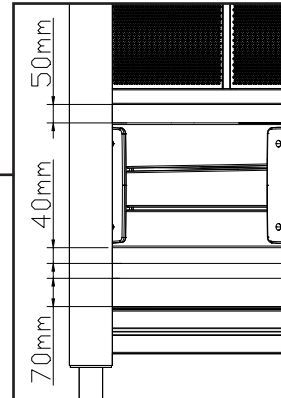

● MA45060740  
x4

● ST4203  
8060708

● ST4203  
8066760

● ST4203  
8060706

● ST4203  
8060708

● ST4203  
8060706

● ST4203  
8066754

● 42060530  
+0,36

● ST4203  
8060708

● ST4203  
8060706

● ST4203  
8060706

● ST4203  
8060706

● ST4203  
8066760

● ST4203  
8066760

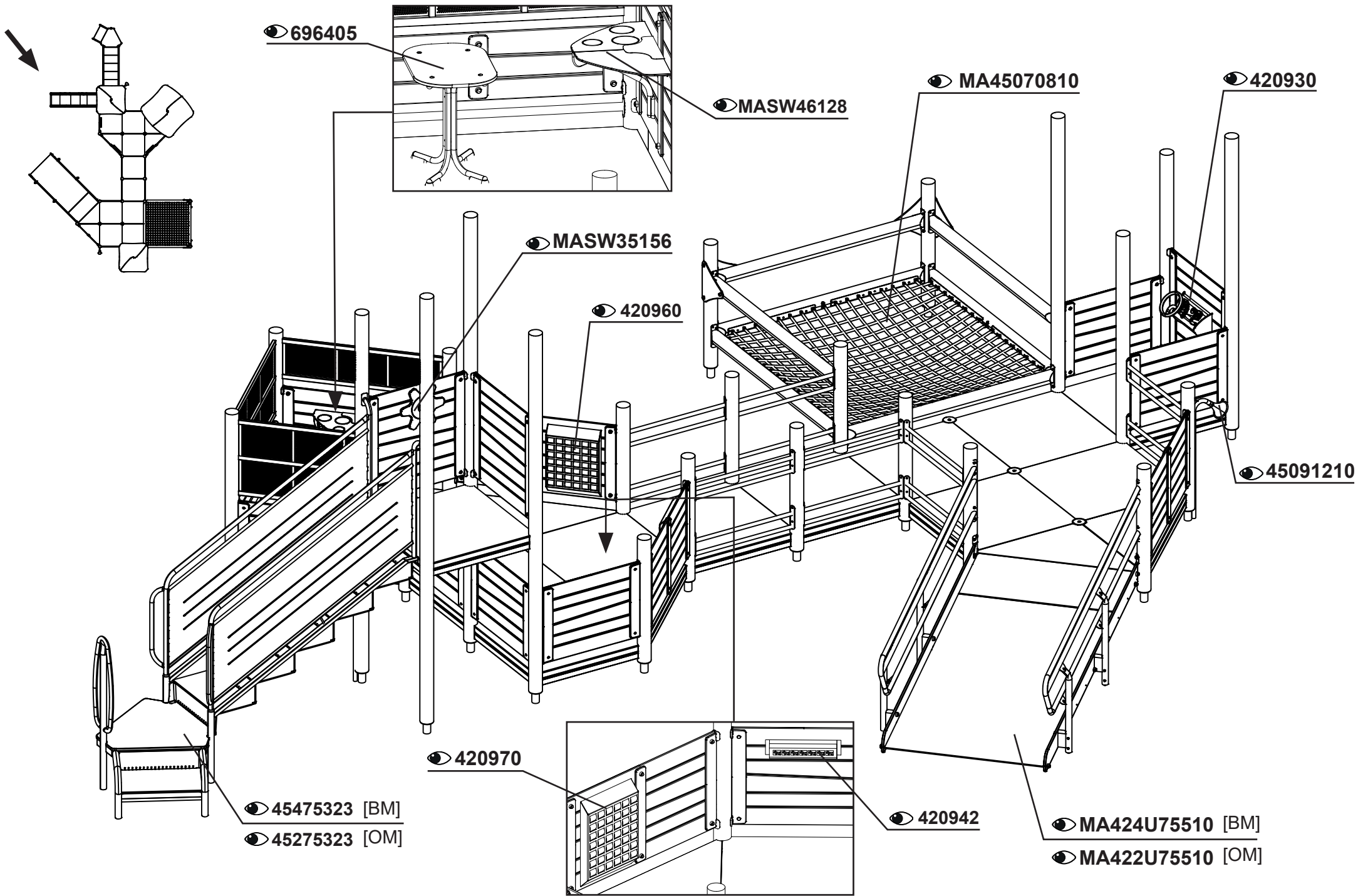

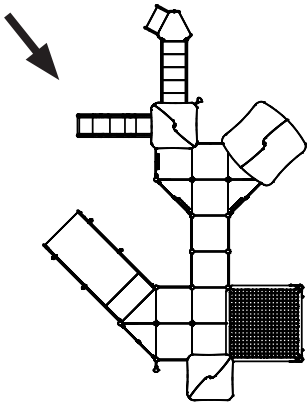

MA62693

MA62483

MA62693

MASW39775  
x13

45091210

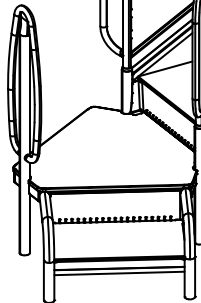
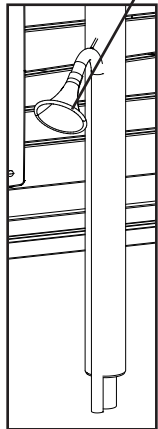

MASW103874 [BM]

MASW85869 [OM]

